



Product Information
Version 2.0

ZEISS LSM 800 with Airyscan Your Compact Confocal for High-End Imaging



Your Compact Confocal for High-End Imaging

- › **In Brief**
- › The Advantages
- › The Applications
- › The System
- › Technology and Details
- › Service

Confocal imaging demands the very best imaging quality. With LSM 800 you choose a flexible and compact confocal laser scanning microscope, complete with highly sensitive GaAsP detection and fast linear scanning. Add Airyscan, the revolutionary detection concept from ZEISS to acquire perfect optical sections with a resolution of 120 nm (in x,y) and 350 nm (in z) even in thick samples. With Airyscan's 4 – 8x better signal-to-noise ratio (SNR) you will be pushing sensitivity and superresolution imaging beyond the limits of all conventional confocals.

LSM 800 is your entry into the world of high-end confocal imaging. Simply decide which options your system needs today, then upgrade in the future as your needs grow.

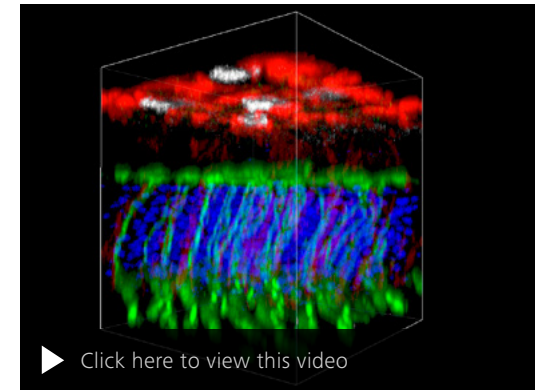

▶ Click here to view this video

Mouse retina. Mueller cells stained for RFP (red), Amacrine cells stained for Chat (green), Cone photo receptors stained for mCar (white) and DNA stained with Hoechst (blue); Sample: courtesy of B. Roska, Friedrich Miescher Institute for Biomedical Research, Basel, Switzerland.

See for yourself how LSM 800 with Airyscan will increase your productivity. Book a hands-on demonstration in one of our ZEISS Microscopy Labs now. >> www.zeiss.com/lsm800

Simpler. More Intelligent. More Integrated.

- › In Brief
- › **The Advantages**
- › The Applications
- › The System
- › Technology and Details
- › Service

Perfectly Tailored to Your Needs

With up to three highly sensitive GaAsP detectors and fast linear scanning, LSM 800 brings you higher productivity and throughput, greater flexibility in live cell imaging and uncompromised image quality. Use this compact confocal for precise quantitative measurements.

Then take advantage of Airyscan, the revolutionary detection concept. You get superresolution with 120 nm in x/y and 350 nm in z. Plus, you get higher sensitivity than with any detection method classic confocals can deliver.

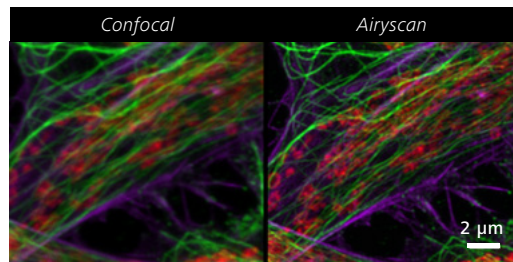

Enhanced resolution and sensitivity of multi-color samples, without changing sample preparation. Comparison between confocal and Airyscan image. HeLa cells, red: mitochondria membran, green: microtubuli, magenta: actin fibers. Sample: courtesy of A. Seitz, Bioluminescence and Optics Core Facility, EPFL, Lausanne, Switzerland.

Use Open Interfaces to Extend Your System

Give your lab or multi-user facility the full benefits of integrated incubation solutions and state-of-the-art Axiocams. LSM 800 uses intuitive ZEN imaging software for complex automated imaging routines with Experiment Designer. Yet it's just as easy to exchange data with third party software and define your own application world using the powerful Open Application Development (OAD). ZEISS Shuttle & Find for correlative microscopy connects LSM 800 with your ZEISS electron microscope.

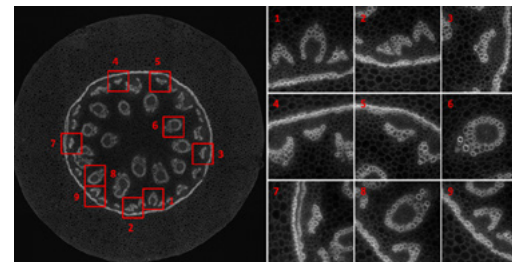

Open Application Development (OAD) is the open and well-documented Python interface for ZEN imaging software. The example shows rare event detection whereby the scan is analyzed and interesting regions re-scanned at high resolution.

Your Compact System for High-end Confocal Imaging

LSM 800 makes excellent economic sense: an affordable system with an attractive price / performance ratio. It's robust and easy to use, with a small footprint and minimal setup requirements – combined with minimal maintenance, minimal training, self-calibration and low energy consumption. That adds up to a predictable cost of ownership over its entire lifetime.

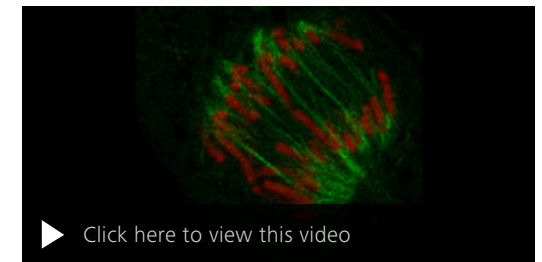

Combine spatial and temporal resolution with truly gentle imaging to analyze cell division processes. Culture of living LLC-PK1 (Pig Kidney Epithelial) cells, green: tubulin-GFP, red: H2B-mCherry.

Your Insight into the Technology Behind It

- › In Brief
- › **The Advantages**
- › The Applications
- › The System
- › Technology and Details
- › Service

Revolutionize Your Confocal Imaging with ZEISS Airyscan

Airyscan is a detector that draws on the fact that a fluorescence microscope will image a point-like source as an extended Airy disk (Airy pattern). In a standard confocal microscope the out-of-focus emission light is rejected at a pinhole, the size of which determines how much of the Airy pattern reaches the detector. When you close the pinhole to reject out-of-focus light, you get a sharper image, but it's also dimmer since a great deal of light is then lost.

The smaller the pinhole, the higher the resolution, but – equally – the greater the loss in light. Airyscan solves this conundrum between resolution and light efficiency by imaging the Airy disk onto a concentrically-arranged hexagonal detector array. Its detection area consists of 32 single detector elements, each of which acts like a very small pinhole. The confocal pinhole itself remains open and doesn't block light – thus all photons of the whole Airy disk are collected.

The signals from all detector elements are then reassigned to their correct position, producing an image with increased signal-to-noise ratio and resolution. An area detector consisting of multiple detector elements allows great flexibility in imaging modes. Instead of closing the pinhole and universally blocking light, each photon from the z-section is kept. The additional information about the Airy pattern gives access to a perfect optical section with highest sensitivity. Airyscan works with your standard samples and dyes. It's your choice, whether you use it to get better SNR, superresolution or speed.

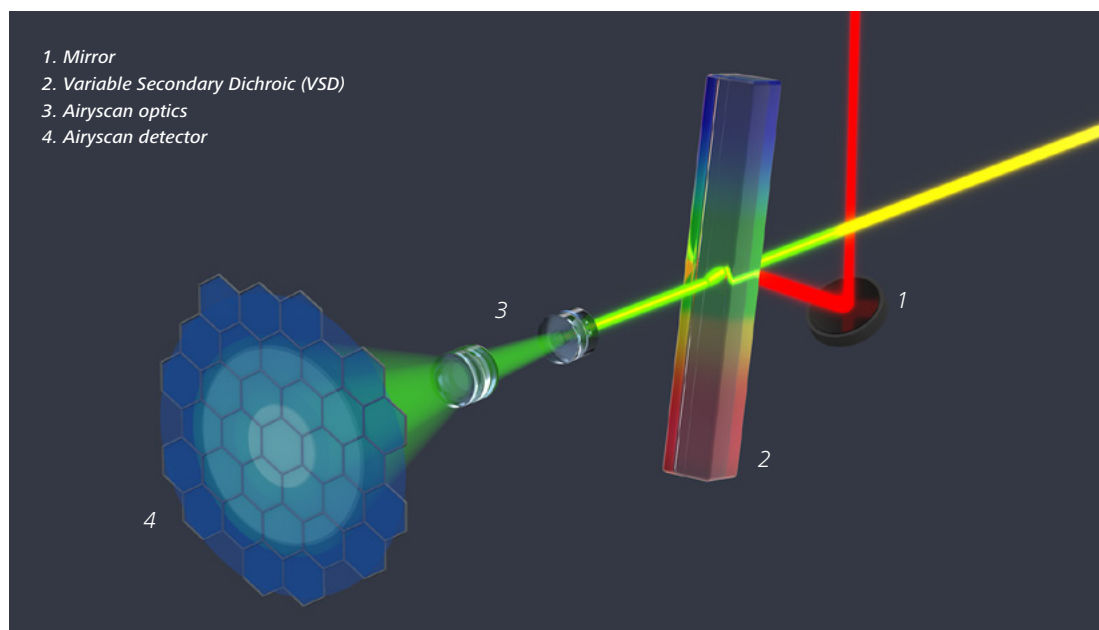

Schematic beam path of ZEISS Airyscan.

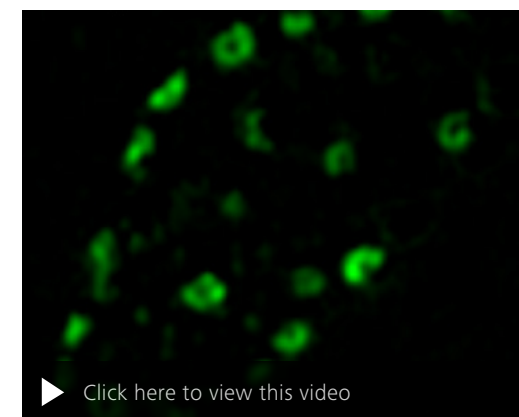

Drosophila melanogaster neuromuscular junction stained for Bruchpilot (BRP). Comparison between confocal GaAsP and Airyscan detection. Sample: courtesy of J. Pielage, Friedrich Miescher Institute for Biomedical Research, Basel, Switzerland.

Your Insight into the Technology Behind It

- › In Brief
- › **The Advantages**
- › The Applications
- › The System
- › Technology and Details
- › Service

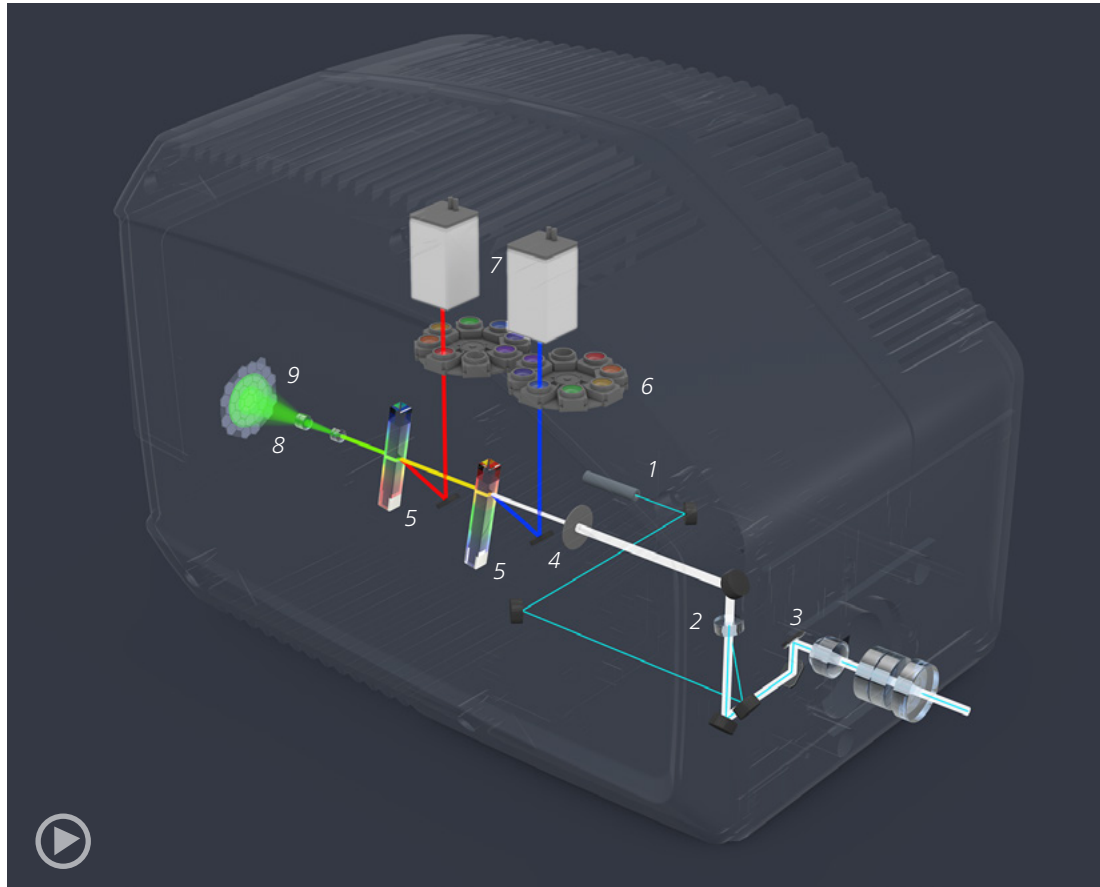

Schematic beam path of ZEISS LSM 800

- | | |
|--------------------------------------|-----------------------|
| 1. Excitation laser lines | 6. Emission filters |
| 2. Main beam splitter (MBS) | 7. Confocal detectors |
| 3. Galvo scanning mirrors | 8. Airyscan optics |
| 4. Pinhole | 9. Airyscan detector |
| 5. Variable Secondary Dichroic (VSD) | |

A Streamlined Light Path with Surprising Flexibility

The compact light path with a minimum of optical elements is designed for highest efficiency. Fluorescence emission light travels through the main dichroic beam splitter with its outstanding laser suppression to deliver supreme contrast. Up to two patented variable beam splitter dichroics (VSDs) divert the spectral part of the light. You can define up to three detectors (multialkali, GaAsP or Airyscan).

Your Insight into the Technology Behind It

- › In Brief
- › **The Advantages**
- › The Applications
- › The System
- › Technology and Details
- › Service

Fast and Linear Scanning – Your Powerful Combination

LSM 800 gives you the benefit of increased scanning speeds so you can resolve those fast movements of labeled proteins that demand equally fast scanning. At an image size of 512×512 pixels you will be capturing events with up to 8 frames per second. Your LSM 800 is constantly monitoring and calibrating the scanner position so you can count on a stable and even field of view with constant pixel times across the whole observation area. This patented linear scanning regime gives you a constant signal-to-noise level and uniform exposure by the illuminating laser throughout the scanned area, including your manipulated regions of interest. With LSM 800 you will be using more than 80% of the scanning time for data acquisition. Signal-to-noise improves by about 29% compared to sine scanning systems. Your experiments will always deliver quantitative data. Likewise, you can adapt the scan field at any time by panning or cropping it, and rotating it freely to best suit the geometry of your sample.



This example shows gentle live cell imaging for over 24 hours with Fox Lung cells tagged with eGFP-Tubulin & mCherry-H2B. Continued cell division for 24 hours.

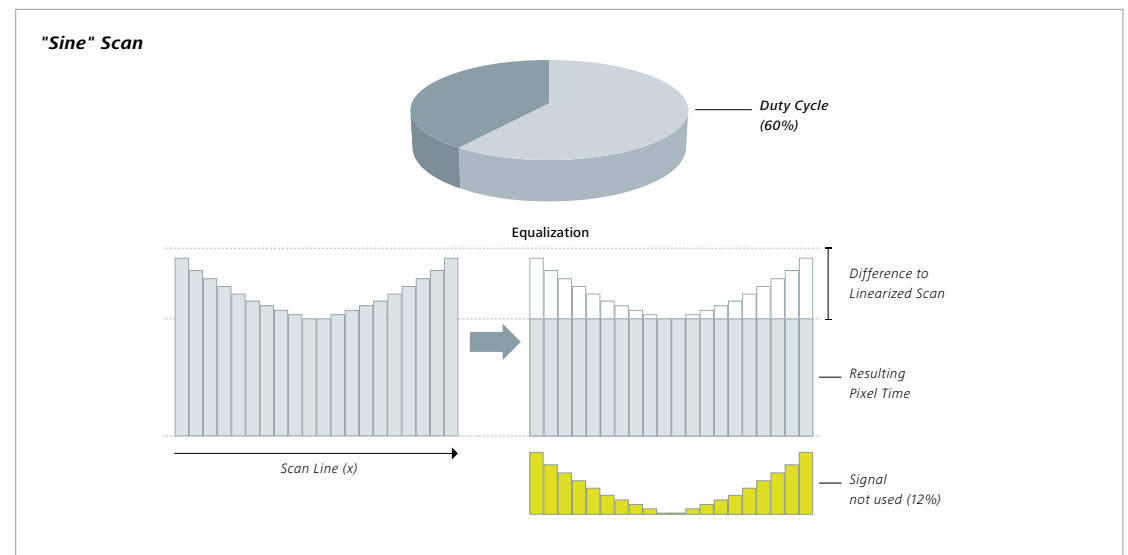
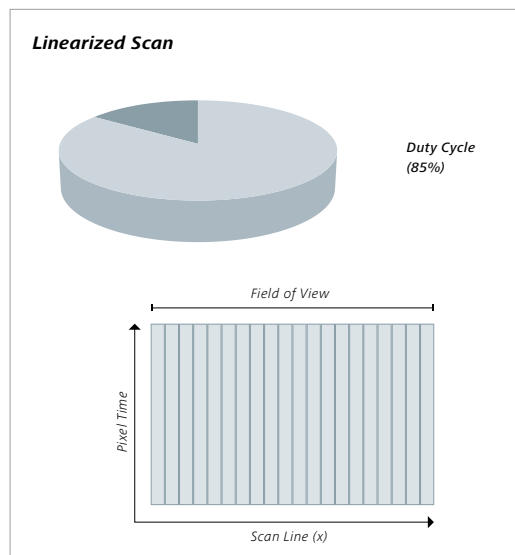

Your Insight into the Technology Behind It

- › In Brief
- › **The Advantages**
- › The Applications
- › The System
- › Technology and Details
- › Service

GaAsP Detectors – Your Choice for Highest Sensitivity

GaAsP PMTs – that is, gallium arsenide phosphide photomultiplier tubes – display high light collection efficiencies over a broad spectral range. Their low dark noise levels also render them the ideal tool for detecting faint signals. Enjoy outstanding image quality based on a superb signal-to-noise ratio (SNR). You might use this gain in SNR to increase productivity by achieving faster scan speeds while preserving excellent image quality. Or take advantage of the low laser powers needed in live cell imaging applications to avoid photobleaching and phototoxicity as much as possible. Or simply detect faint signals in low expressing cells. All that, and you can do it with up to three spectral channels simultaneously.

Benefit from up to Three Confocal Detectors

Investigations into localization and interaction of proteins often require multiple fluorescent labels with overlapping emission spectra. Now you can image up to four dyes, crosstalk free by multi-tracking. Or even more by performing a Lambda scan with spectral unmixing.

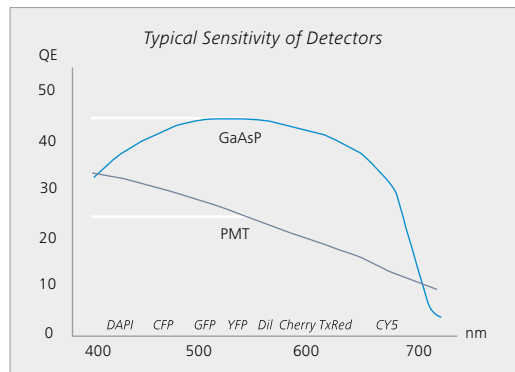

Typical spectral quantum efficiency (QE) of PMT and GaAsP detectors.

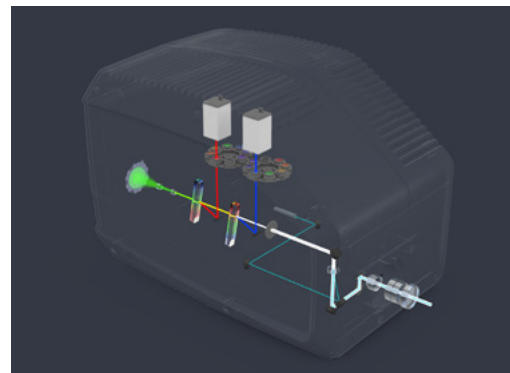

Schematic beam path of ZEISS LSM 800.

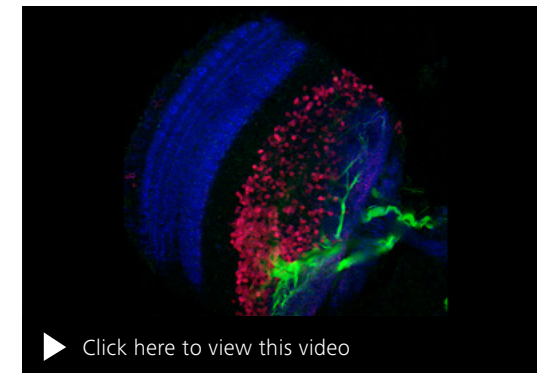

▶ [Click here to view this video](#)

Drosophila brain; triple antibody staining: Alexa 488, Alexa 568 and Alexa 633; Sample: courtesy of D. Reiff, Institute of Biology, Albert-Ludwigs-University Freiburg, Germany.

Expand Your Possibilities

- › In Brief
- › **The Advantages**
- › The Applications
- › The System
- › Technology and Details
- › Service

Experiment Designer

Use Experiment Designer to automate complex acquisition strategies. Exploit and combine different imaging modalities. Execute repetitive imaging of a large number of samples. The smart automation module for enhanced productivity helps you to get results that are statistically validated.



Autocorr Objectives

With Autocorr objectives and ZEN imaging software it's easy to adjust your microscope optics to your sample. You get crisp contrast and better signal-to-noise – even deep in your most challenging samples.



3D Visualization

3Dxl Viewer – powered by arivis – is the new visualization tool for the large, high resolution data sets you acquire with LSM 800 and Airyscan. Create impressive 3D animations or fly-through videos. Or simply study your sample from all sides and get a better understanding of its three-dimensional organization. With ZEN imaging software and the module 3Dxl – powered by arivis – you handle even the most demanding multidimensional data sets.

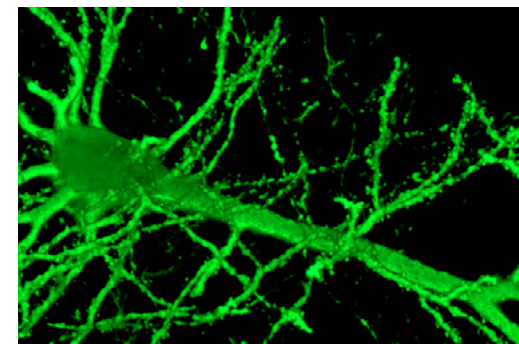

Mouse brain, cleared with CLARITY. Neurons labeled with Thy1-GFP. Detail rendering of the dataset shown on page 17. Acquired with ZEISS LSM 800 on ZEISS Axio Examiner.Z1. Courtesy of T. Ruff, Max Planck Institute of Neurobiology, Martinsried, Germany.

Expand Your Possibilities

- › In Brief
- › **The Advantages**
- › The Applications
- › The System
- › Technology and Details
- › Service

Correlative Microscopy

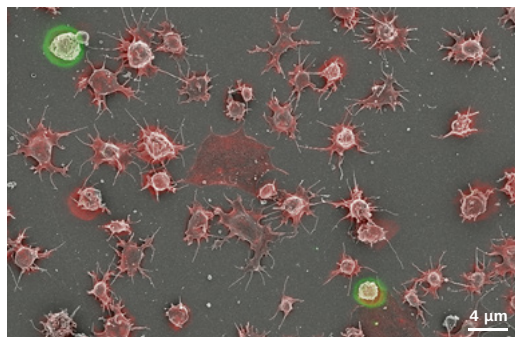
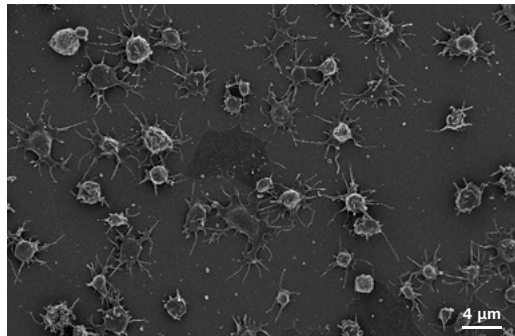
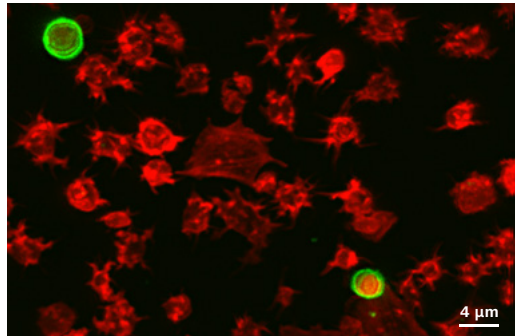

Platelets stained for cellular platelet protein (green) and actin (red). Upper image: LSM fluorescence image; center image: SEM image; bottom image: overlay. Courtesy of D. Woulfe and J. Caplan, University of Delaware, Newark, USA.

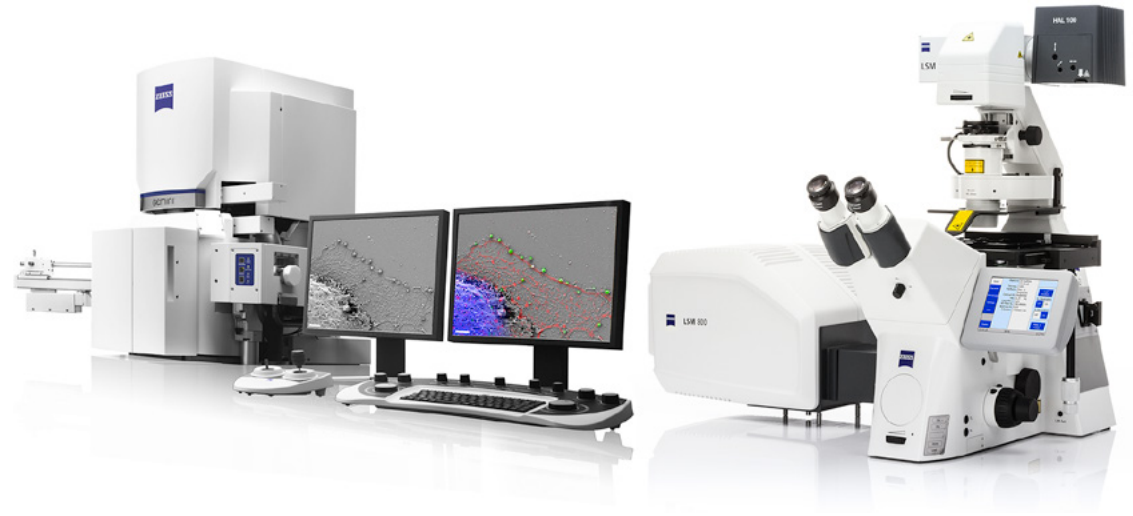

To map the distribution of fluorescently labeled proteins to subcellular structures with the highest precision, the Shuttle & Find module is your technology of choice. A wizard-guided easy-to-use workflow between light and scanning electron microscope delivers reliable relocation of defined regions of interest. Images from both microscopical methods can be overlaid to one correlative image revealing functional information within an ultrastructural context.

Expand Your Possibilities

- › In Brief
- › **The Advantages**
- › The Applications
- › The System
- › Technology and Details
- › Service

OAD is Your Interface to ZEN Imaging Software

- Use Python scripts to customize and automate your workflows.
- Integrate external image analysis applications into your workflow.
- Exchange image data with external programs like ImageJ, Fiji, MATLAB, KNIME or Python.
- Use feedback for smart experiments.
- Get more reliable data in less time.
It's your choice.

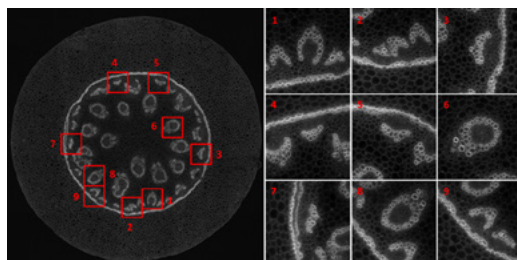

Rare event detection. A Convallaria sample was scanned and the image analyzed for features. Areas with hits were re-scanned at higher magnification.



OAD enables the analysis of data acquired with ZEN imaging software by other programs like ImageJ. Transfer your results back to ZEN for further analysis and display.

Expand Your Possibilities

- › In Brief
- › **The Advantages**
- › The Applications
- › The System
- › Technology and Details
- › Service

As your needs grow, LSM 800 grows with you, forming the basis for a number of enhancements. Like every system from ZEISS, LSM 800 comes with open interfaces and a modular architecture to guarantee the seamless interaction of all components, now and in the future.



Combine ZEISS Axio Observer with incubation to get the best tool for long-term live cell imaging with stable temperature conditions.



Add the newest choice of cameras from the ZEISS AxioCam series to ZEISS LSM 800 for widefield imaging experiments.



ZEISS Shuttle & Find is your gateway to correlative light and electron imaging (CLEM). Combine the specificity of functional fluorescence imaging with ultrastructural information.



Z piezo stage and a leveling insert guarantee the precision needed for superresolution applications using ZEISS Airyscan.

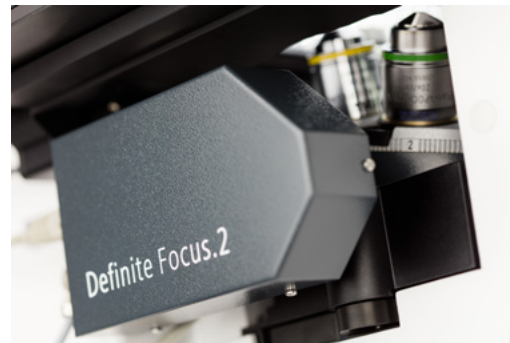

Definite Focus.2 stabilizes the focal position of your sample compensating Z-drift. You can now perform long-term experiments that can last for multiple days.



The electronically switchable illumination and detection module (ESID) combines transmitted light illumination and detection in one component. No mechanical parts need to be moved when switching between modes.

Expand Your Possibilities

- › In Brief
- › **The Advantages**
- › The Applications
- › The System
- › Technology and Details
- › Service

Use the outstanding sensitivity of LSM 800 for the study of protein dynamics in living cells.

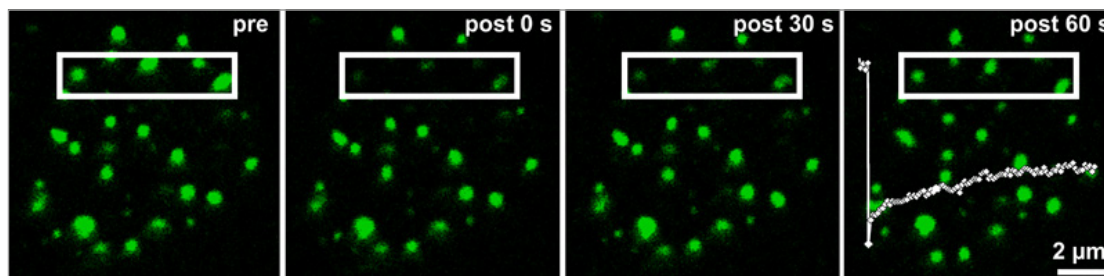

Use FRAP to study protein dynamics. The example shows EGFP-CENPI in HepG2 cells before bleach ("pre"), and at the indicated time points after the bleach ("post"). The recovery curve (superimposed in the last image and showing the recovery from bleach at 0 s to 60 s, intensities in AU) can be used to calculate the diffusion coefficient of the molecule.

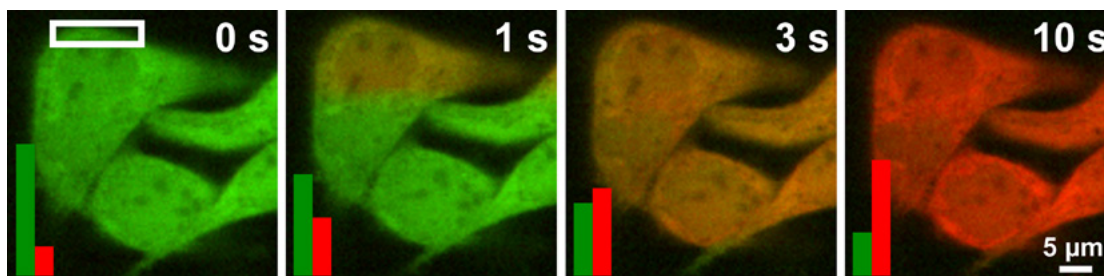

Photoactivation is your method of choice to study the fate of proteins. The example shows Kaede expressed in HepG2 cells before photoactivation (0 s) and at different time points (1 s, 3 s and 10 s) after repeated photoactivation (every 0.1 s) with 405 nm at the indicated regions (white box). Kaede diffuses freely between the nucleus and the cytoplasm. The relative intensities in AU of the non-converted form (green bars) and converted form (red bars) are shown in each image.

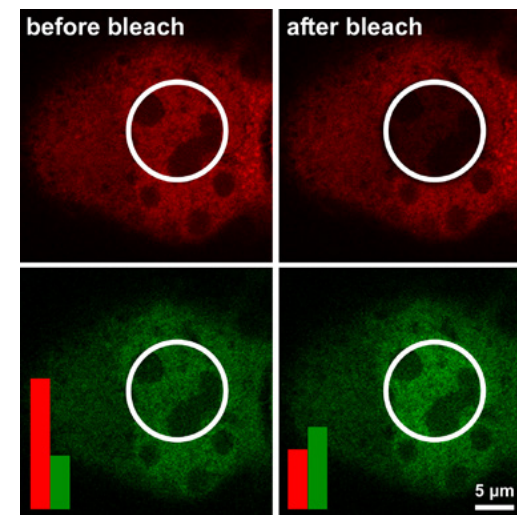

FRET is your tool for investigation of protein interaction. The example shows two interacting proteins (donor false colored in green, acceptor false colored in red) in HepG2 cells ("before bleach"). By acceptor-photobleaching (within the indicated white circle) acceptor intensity will decrease, while donor intensity will increase ("after bleach") as indicated by the green (donor) and red (acceptor) bars. The increase in donor intensity can be used to calculate FRET efficiencies.

Tailored Precisely to Your Applications

- › In Brief
- › The Advantages
- › **The Applications**
- › The System
- › Technology and Details
- › Service

Typical Applications, Typical Samples	Task	ZEISS LSM 800 Offers
Antibody stained tissue slices	Document morphological relations of structures with a resolution of 120 nm (xy) / 350 nm (z) at 488 nm excitation	Airyscan with GaAsP detector for superresolution imaging
Live cell culture	Study the motility of vesicles and organelles	Up to 8 frames per second time lapse imaging
	Screen and document cells expressing the desired fluorescent label in response to pharmacological treatment	Widefield imaging using AxioCam
Live cell culture with two labels	Study the motility of subcellular structures	Airyscan with GaAsP detector to image with time lapse imaging in 2D or 3D at 1.6 frames per second
	Explore the interaction of two proteins exploiting the Förster Resonance Energy Transfer effect	FRET analysis tool, available in ZEN (black edition)
Live cells with multiple labels	Image over a long time in an automated way	Experiment Designer software tool combined with three parallel spectral channels
Live or fixed cells with multiple labels and overlapping emission signals	Examine the interplay of multiple proteins	Parallel acquisition of all signals with three spectral channels and linear unmixing
Cellular structures with weak labels	Image subcellular structures at physiological expression levels	LSM 800 with GaAsP detector or Airyscan
Study molecular dynamics	Photomanipulation	FRAP analysis tool, available in ZEN (black edition), classical timed bleaching or flexible interactive bleaching strategies
Plant roots	Follow the changes of subcellular structures over time with high resolution	Airyscan with GaAsP detector for superresolution imaging beyond 40 µm deep into tissue with up to 1.6 full frames per second (512 × 512 pixel)
Model organisms, e.g. Zebrafish, <i>Drosophila</i> or <i>C. elegans</i> , <i>Arabidopsis</i>	See fine details of the organization and dynamics of endogeneously expressed FP proteins	Airyscan with GaAsP detector for superresolution imaging beyond 40 µm deep into tissue. 20x / NA 1.0 water immersion objective available for LSM 800 on Axio Examiner.Z1*
Cleared samples	Image whole organs or entire organisms	Specialized objectives with long working distance and optimized for specific refractive indices are available for LSM 800 on Axio Examiner.Z1*, (e.g. 20x NA 1.0 objectives for refractive index of 1.38 and 1.45)

(*available on request)

ZEISS LSM 800 at Work

- › In Brief
- › The Advantages
- › **The Applications**
- › The System
- › Technology and Details
- › Service

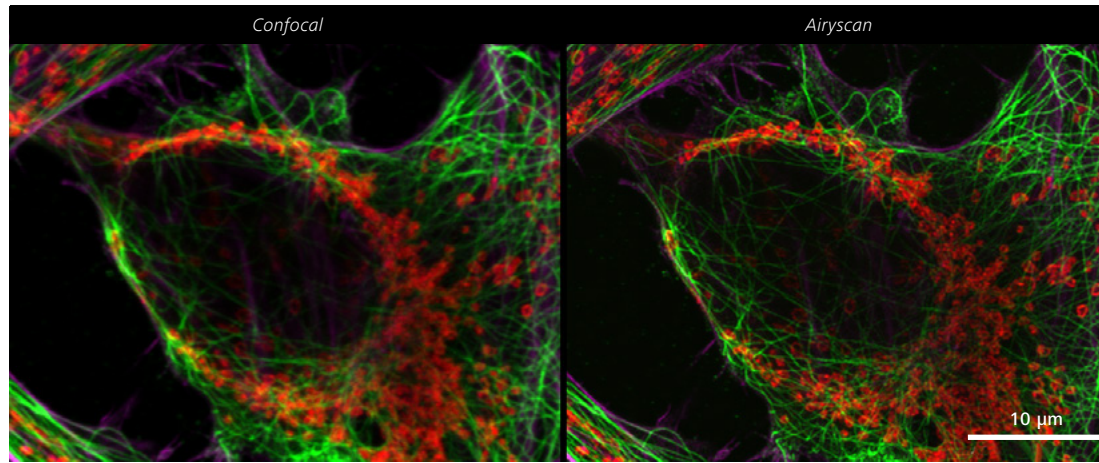

Comparison between confocal and Airyscan image. HeLa cells, red: mitochondria membrane, green: microtubuli, magenta: actin fibers. Sample: courtesy of A. Seitz, Biolmaging and Optics Core Facility, EPFL, Lausanne, Switzerland.

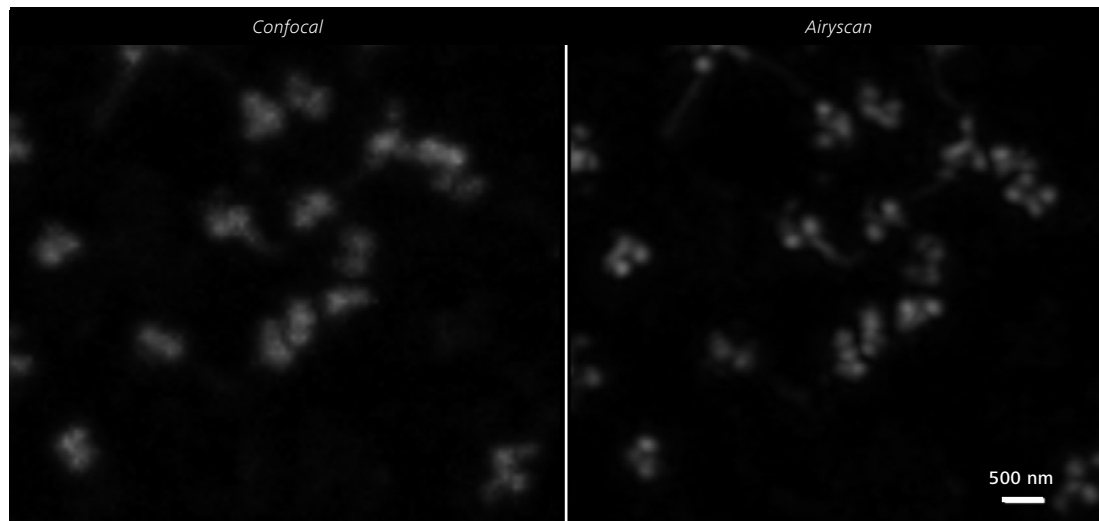

Isolated centrioles of Chlamydia; fixed with Methanol; Tubulin staining with Alexa 488. Sample: courtesy of P. Guichard, EPFL, Lausanne, Switzerland.

ZEISS LSM 800 at Work

- › In Brief
- › The Advantages
- › **The Applications**
- › The System
- › Technology and Details
- › Service

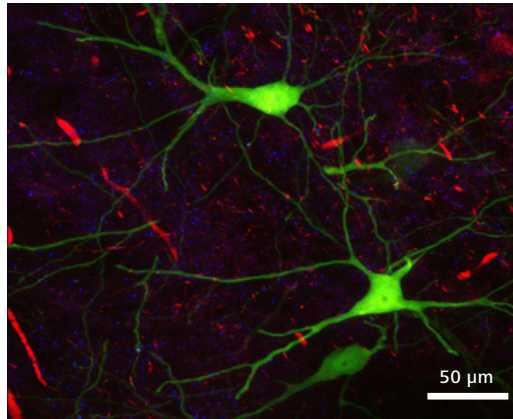

Mouse brain slice, EGFP-Thy1 (green): nerve cells (subset), Calretinin-Cy3 (red): Calretinin-expressing neurons, GAD65-Cy5 (blue): GABAergic synapses; Sample: courtesy of P. Janz, Neuropathology, University Freiburg, Germany.

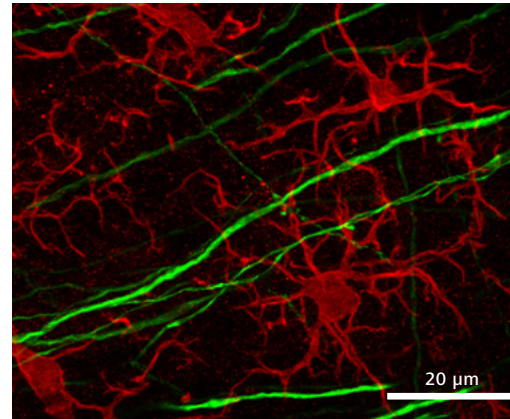

Mouse brain slice, EGFP-Thy1: nerve cells, Iba1-Cy3: microglia cells; Sample: courtesy of P. Janz, Neuropathology, University Freiburg, Germany.

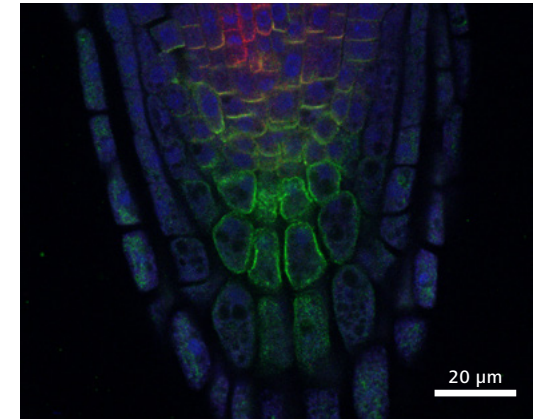

Arabidopsis thaliana root, PIN1 (red), PIN4 (green), DAPI (blue); Sample: courtesy of T. Pasternak, Institute of Biology, Albert Ludwigs University Freiburg, Germany.

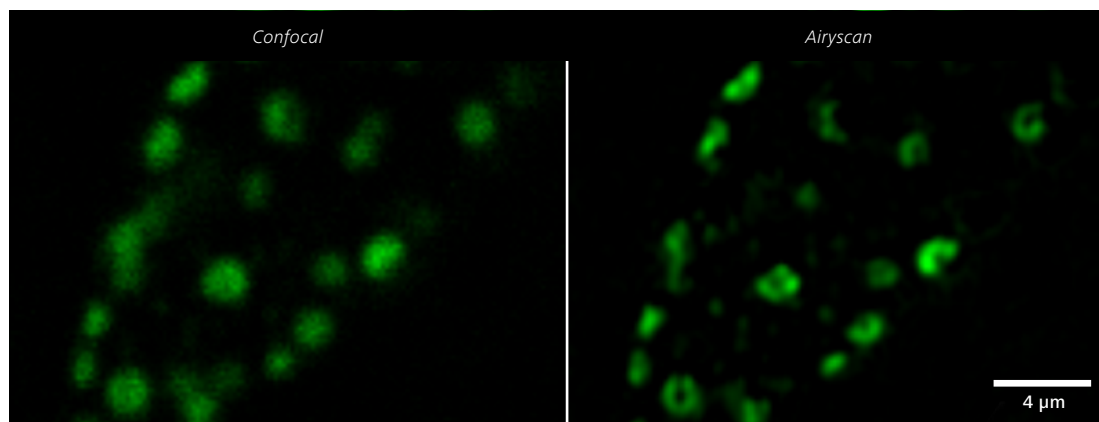

Drosophila melanogaster neuromuscular junction stained for Bruchpilot (BRP). Comparison between confocal GaAsP (left) and Airyscan (right) detection. Sample: courtesy of J. Pielage, Friedrich Miescher Institute for Biomedical Research, Basel, Switzerland.

ZEISS LSM 800 at Work

- › In Brief
- › The Advantages
- › **The Applications**
- › The System
- › Technology and Details
- › Service

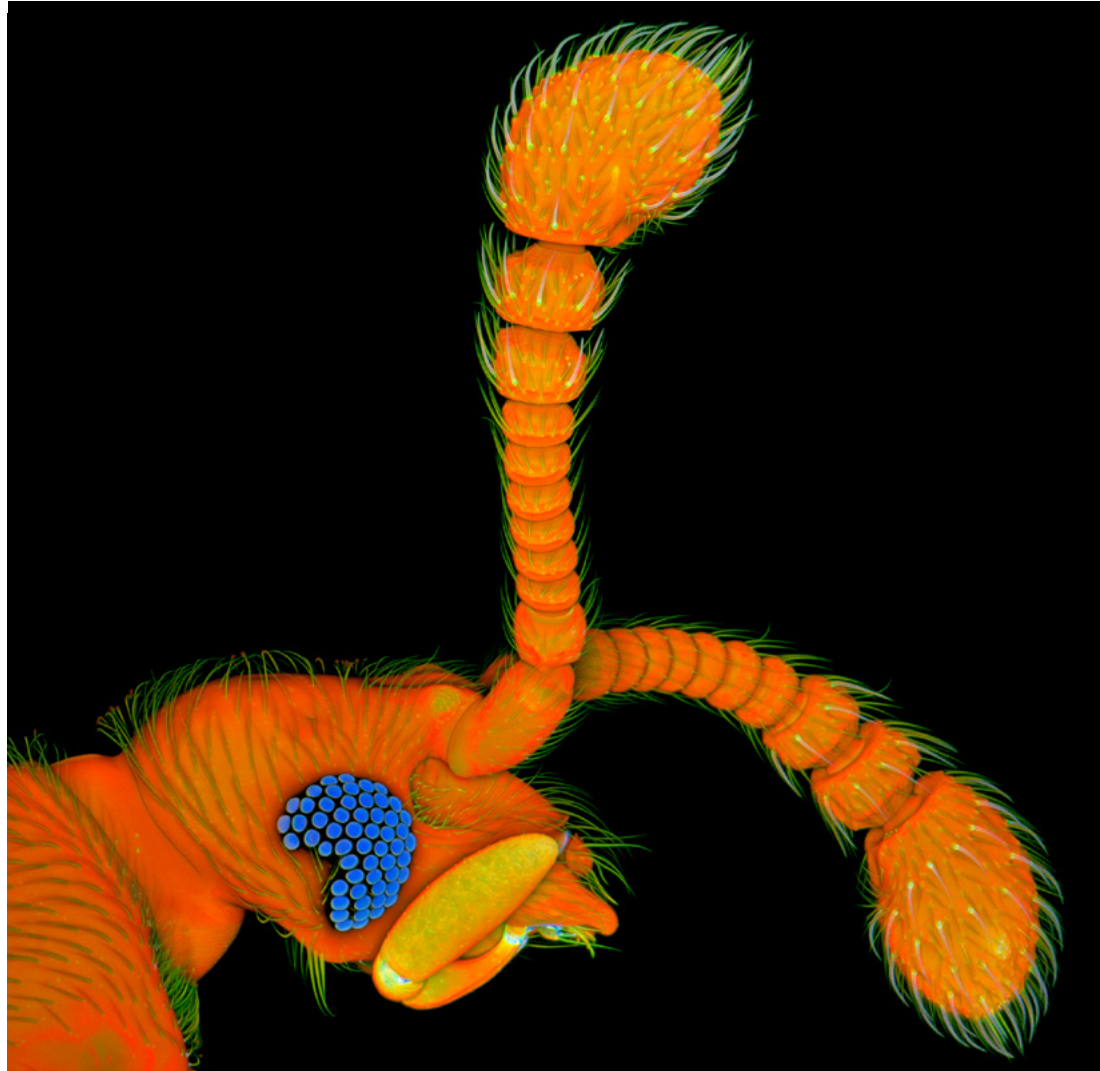

Beetle of the genus Circocerus, collected in the Peruvian lowland Amazon rainforest. Visualization of different autofluorescences exhibited by the exoskeleton. Courtesy of J. Michels, Zoological Institute, Kiel University, Germany.

ZEISS LSM 800 at Work

- › In Brief
- › The Advantages
- › **The Applications**
- › The System
- › Technology and Details
- › Service

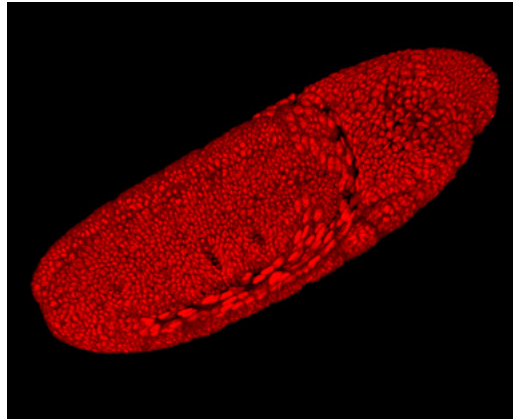

Drosophila gastrulation, nuclei labeled with H2 Av-RFP. Acquired with ZEISS LSM 800 on ZEISS Axio Examiner.Z1. Courtesy of J. Bonnet, Max Planck Institute of Biochemistry, Martinsried, Germany.

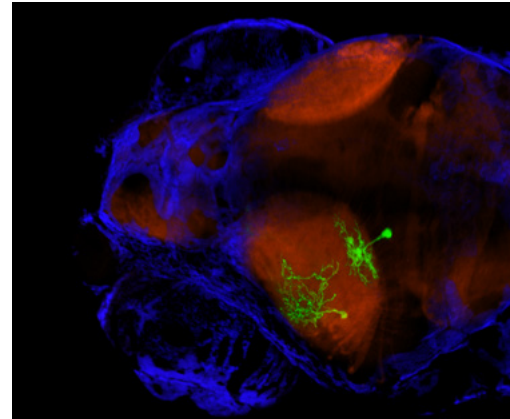

Live Zebrafish, single neurons sparsely labeled with GFP, pan-neuronal labeling with tagRFP. Skin was recolored and clipped in front of the neurons. Acquired with ZEISS LSM 800 on ZEISS Axio Examiner.Z1. Courtesy of E. Laurell, Max Planck Institute of Neurobiology, Martinsried, Germany.

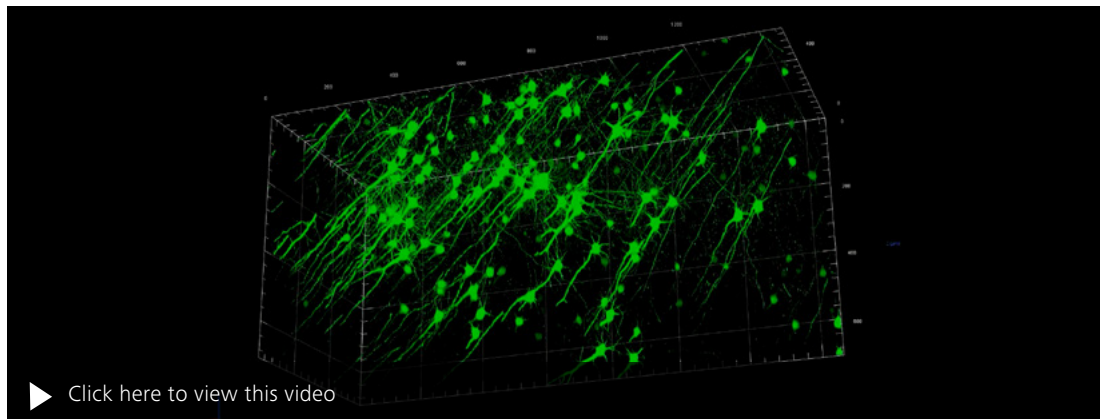

Mouse brain, cleared with CLARITY. Neurons labeled with Thy1-GFP. Acquired with ZEISS LSM 800 on ZEISS Axio Examiner.Z1. Dataset size is about 100 GB (10 tiles and 800 μ m depth) and it was rendered using the ZEN imaging software and 3Dxl viewer – powered by arivis. Courtesy of T. Ruff, Max Planck Institute of Neurobiology, Martinsried, Germany.

ZEISS LSM 800: Your Flexible Choice of Components

- › In Brief
- › The Advantages
- › The Applications
- › **The System**
- › Technology and Details
- › Service

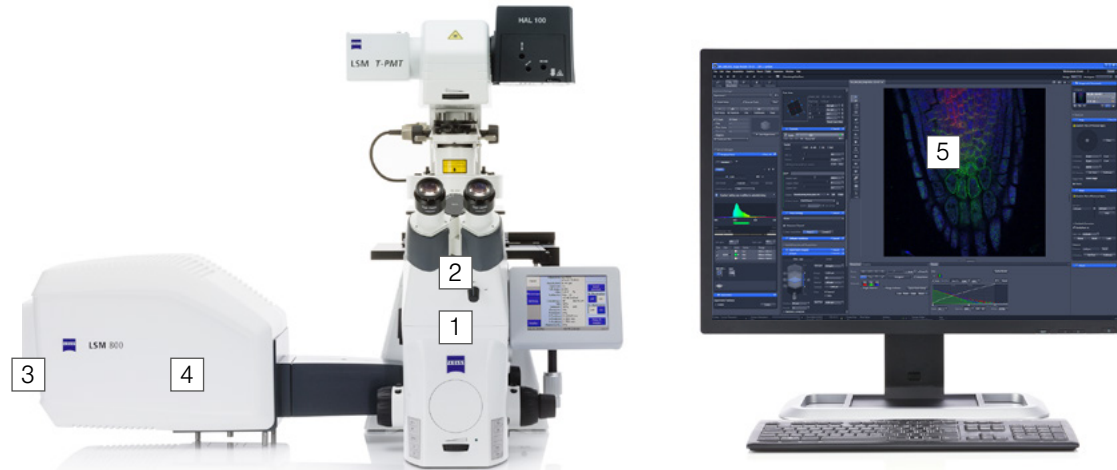

1 Microscope

- Inverted stand: Axio Observer 7
- Upright stands: Axio Imager.M2, Axio Imager.Z2, Axio Examiner.Z1*
- Camera port
- Manual or motorized stages
- Incubation solutions
- Fast Z piezo inserts (for inverted stands)
- Definite Focus.2

2 Objectives

- C-APOCHROMAT
- Plan-APOCHROMAT
- LD Plan-APOCHROMAT
- EC Plan-NEOFLUAR

3 Illumination

- Diode lasers: 405, 488, 561 and 640 nm

4 Detection

- 2 channel Gallium Arsenide Phosphid (GaAsP) PMT or 2 channel multialkali (MA) PMT
- 1 additional GaAsP PMT, MA PMT or Airyscan detector for 40x or 63x objectives
- Electronically switchable illumination and detection module (ESID) or transmitted light detector (T-PMT) with halogen lamp (HAL)

5 Software

- ZEN (blue edition), recommended modules: Tiles & Positions, Experiment Designer, 3Dxl Viewer – powered by arivis®

(*available on request)

ZEISS LSM 800: System Overview

- › In Brief
- › The Advantages
- › The Applications
- › **The System**
- › Technology and Details
- › Service

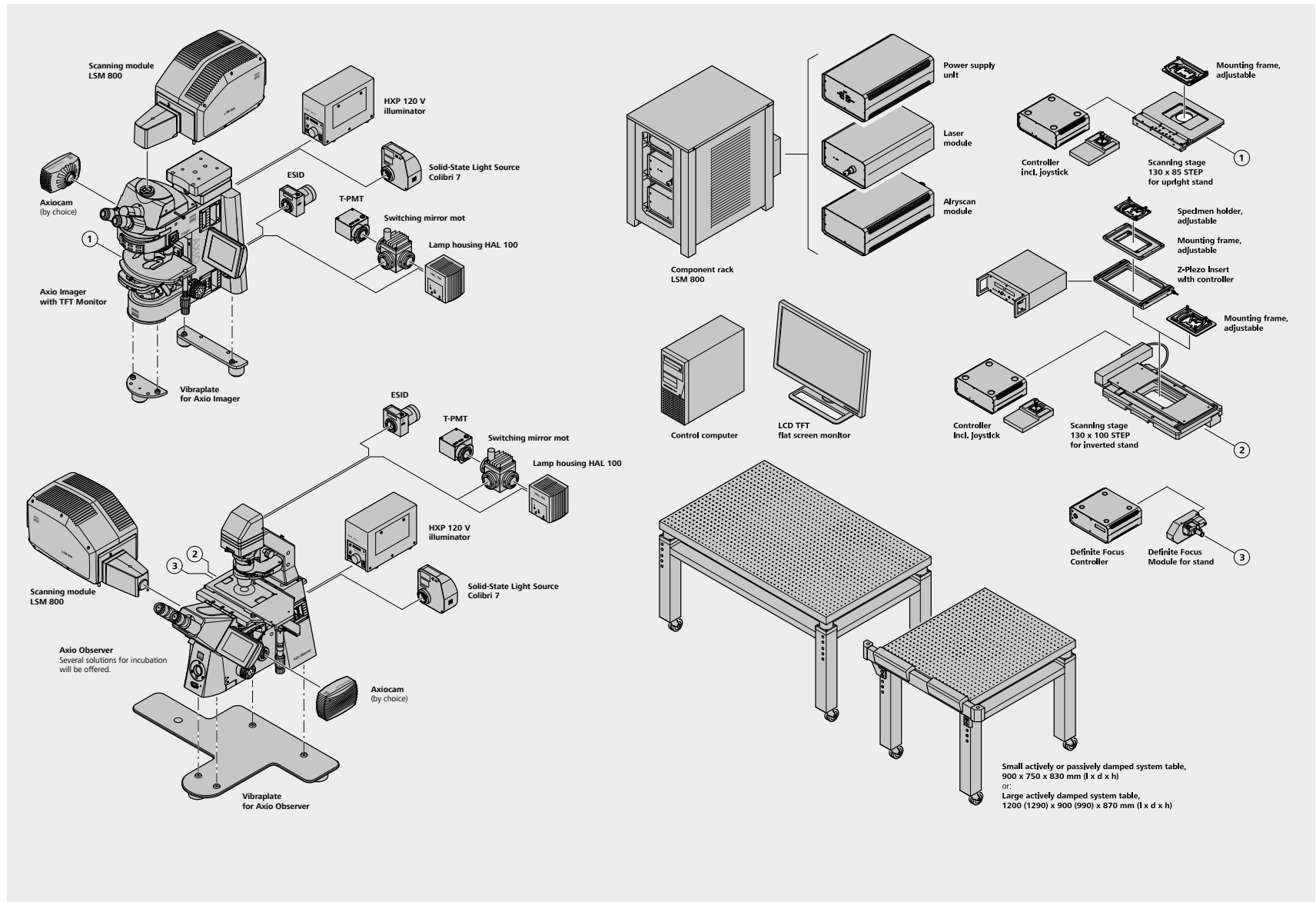

Technical Specifications

- › In Brief
- › The Advantages
- › The Applications
- › The System
- › **Technology and Details**
- › Service

LSM 800 with Axio Observer on small system table

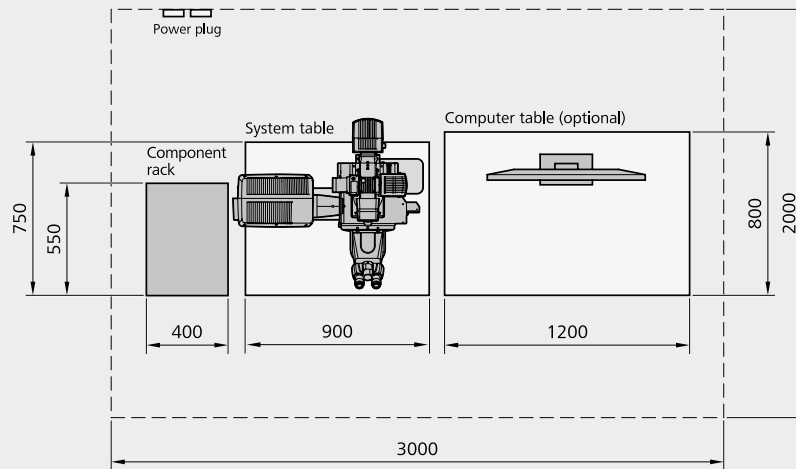

LSM 800 with Axio Imager on small system table

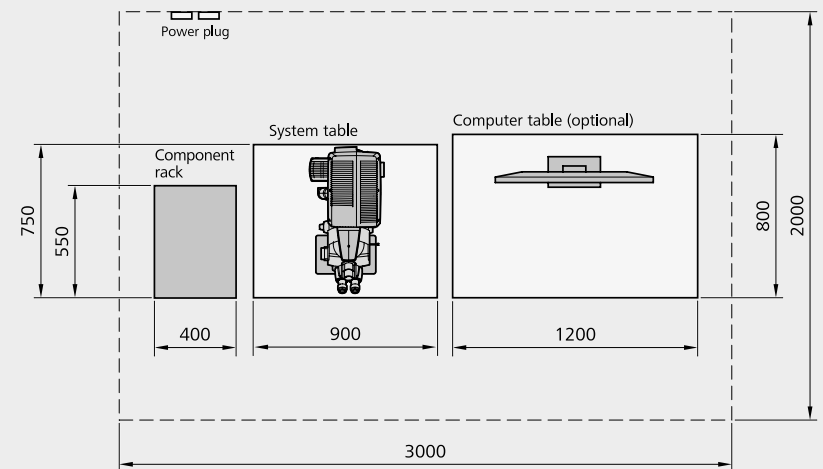

LSM 800 with Axio Observer on large system table

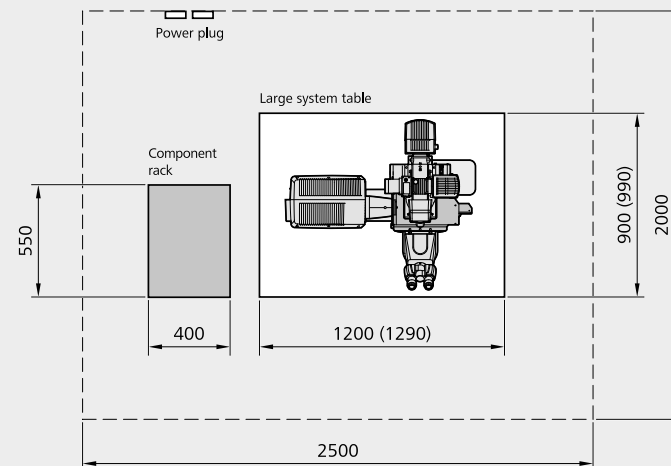

LSM 800 with Axio Imager on large system table

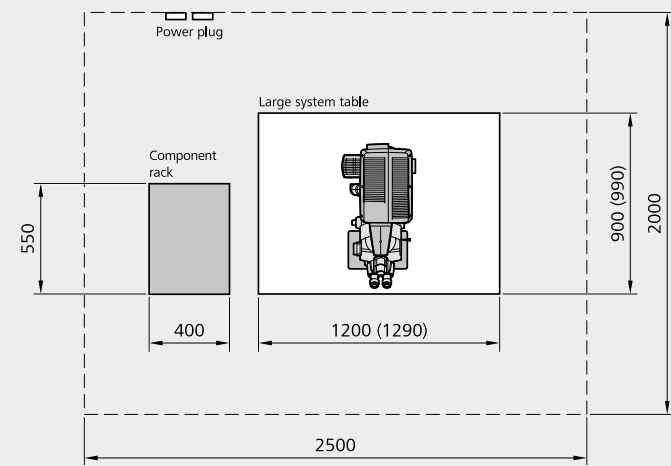

Technical Specifications

- › In Brief
- › The Advantages
- › The Applications
- › The System
- › **Technology and Details**
- › Service

Physical Dimensions	Length (cm)	Width (cm)	Height (cm)	Weight (kg)
Small actively and passively damped system table	90	75	83	130
Large actively damped system table (incl. corner pieces)	120 (129)	90 (99)	87	180
Vibraplate for Axio Imager (consists of three pedestals)	32	30	4.5	1.5
Vibraplate for Axio Observer	52.5	80	4.5	7
Scanning Module LSM 800	40	25.5	28	15
Axio Imager.Z2; Axio Imager.M2	56	39	70	20
Axio Observer 7	61	39	65	20
Component rack	55	40	60	35
Laser module (LM)	40	25	14.5	10
Airyscan (40× and 63×)	40	25	14.5	5
Power supply unit (PSU)	40	25	14.5	6
Fiber optic cable, VIS	300			
Cables	300			
Microscopes				
Stands	Upright: Axio Imager.Z2, Axio Imager.M2, Axio Examiner.Z1* Inverse: Axio Observer 7 with side port			
Z Drive	Smallest increment Axio Observer 7; Axio Imager.Z2: 10 nm; Axio Imager.M2; Axio Examiner: 25 nm; Z-Piezo stage available; Definite Focus.2 for Axio Observer 7			
XY Stage (optional)	Motorized XY scanning stage, for Mark & Find function (xy) as well as Tile Scan (Mosaic Scan); smallest increment of 0.25 μm (Axio Observer 7), 0.2 μm (Axio Imager.Z2)			

(*available on request)

Technical Specifications

- › In Brief
- › The Advantages
- › The Applications
- › The System
- › **Technology and Details**
- › Service

Scanning Module	
Scanner	Two independent, galvanometric scanning mirrors with ultrashort line and frame flyback
Scanning resolution	4 × 1 to 6,144 × 6,144 pixels (Airyscan max. 4,096 × 4,096 pixels), also for multiple channels, continuously adjustable (for each axis)
Scanning speed	Up to 8 images/sec (Airyscan up to 1.6 images/sec) with 512 × 512 pixels; up to 64 images/sec with 512 × 64 pixels
Scanning zoom	0.5× to 40×; continuously adjustable
Scanning rotation	Can be rotated freely (360°), adjustable in increments of 0.1°, freely adjustable xy offset
Scanning field	18 mm diagonal in the intermediate image plane, with full pupil illumination
Pinhole	Master pinhole with preset size and position; can be adjusted as desired for multitracking and short wavelengths (such as 405 nm); automatic alignment
Beam path	One major beam splitter for four laser lines (405, 488, 561 and 640 nm) at 10 degree with excellent laser line suppression. The 640 nm laser line can be used for internal autofocusing. Depending on the system, either one or two patented Variable Secondary Dichroics (VSDs) can be used to flexibly divert the respective spectral range of light to chosen channels. Emission filters can be used to clean up the signal when imaging autofluorescent or highly scattering samples.
Detection Options	
Detectors	2 spectral detection channels, GaAsP (typical QE 45%) or multialkali (MA) PMT (typical QE 25%) 1 additional GaAsP PMT, MA PMT or Airyscan detector Airyscan with spatial detection (32 channels GaAsP) adapted for 40× or 63× objectives Transmitted light detector (ESID or T-PMT)
Spectral detection	>8 sequential confocal fluorescence channels, up to three parallel confocal fluorescence channels, based on low-noise GaAsP or MA PMTs; adjustable in increments of 1 nm
Data depth	8-bit and 16-bit available
Real-time electronics	Microscope, laser, scanning module and additional accessory control; data acquisition and synchronization management through real-time electronics; oversampling read-out logic for best sensitivity; data transfer between real-time electronics and user PC via LVDS with the ability to evaluate the data online during image acquisition

Technical Specifications

- › In Brief
- › The Advantages
- › The Applications
- › The System
- › **Technology and Details**
- › Service

ZEN Imaging Software	
GUI configuration	Workspace to conveniently configure all of the motorized functions of the scanning module, laser and microscope; save and restore application configurations (re-use)
Calibration tools	Calibration objective and software tools to calibrate the system
Recording modes, Smart Setup	Z Stack, Lambda Stack, Time Series and all combinations (xyz, lambda, t), online calculation of signal intensities, average and summation (by line/image, adjustable), Step Scan (for higher image frame rates); quick set up of imaging conditions using Smart Setup by simply selecting the labelling dye
Crop function	Easily select scanning areas (simultaneously select zoom, offset, rotation)
Real ROI Scan	Scans of designated ROIs (regions of interest) as desired and pixel-by-pixel laser blanking
ROI bleaching	Localized bleaching in bleach ROIs for applications such as uncaging; use of different speeds for bleaching and imaging, use of different laser lines for different ROIs; Flexibly define your bleaching experiments during the acquisition with Interactive Bleaching
Multitracking	Rapidly change excitation lines when recording multiple fluorescences for the purpose of minimizing signal crosstalk and increasing dynamic range
Lambda scan	Sequential acquisition of image stacks with spectral information for every pixel
Linear Unmixing	Acquisition of crosstalk-free, multiple fluorescence images using simultaneous excitation; offline unmixing; advanced unmixing logic with indication of reliability
Visualization	XY, orthogonal (XY, XZ, YZ), Cut (3D section); 2.5D for time series of line scans, projections (maximum intensity); animations; depth coding (inverse colors), brightness, gamma and contrast settings; color table selection and modification (LUT), character functions
Image analysis and operations	Co-localization and histogram analysis with individual parameters, profile measurement along user-defined lines, measurement of lengths, angles, areas, intensities and much more; operations: addition, subtraction, multiplication, division, ratio, shift, filters (low-pass, median, high-pass, etc., also user-definable)
Image Management	Features for managing images and the corresponding imaging parameters
Optional Software	
3Dxl Viewer – powered by arivis®	Visualization of very large data sets, fully integrated in ZEN imaging software. Rapid 3D and 4D reconstructions and animations (available modes: shadow projection, transparency projection, maximum intensity projection, mixed mode, surface rendering)
Deconvolution	3D image restoration based on calculated point-spread functions (modes: nearest neighbor, maximum likelihood, constrained iterative)
Physiology	Comprehensive evaluation software for online and offline ratio image calculation and calibration of ion concentrations
Open Application Development (OAD)	Python scripting interface for automation & customization; experiment feedback for Smart Experiments and open interface to third party software (e.g. ImageJ)
Experiment Designer	Definition of advanced automated imaging

Technical Specifications

- › In Brief
- › The Advantages
- › The Applications
- › The System
- › **Technology and Details**
- › Service

Lasers	
Laser module URGB (pigtailed; 405, 488, 561, 640 nm)	Single-mode polarization preserving fiber
	Typical total dynamic range of 10.000:1; direct modulation 500:1
	Diode laser (405 nm, 5 mW); laser class 3B
	Diode laser (488 nm, 10 mW); laser class 3B
	Diode (SHG) laser (561 nm, 10 mW); laser class 3B
Laser module GB (pigtailed; 488, 561 nm)	Diode laser (640 nm, 5 mW); laser class 3B
	Single-mode polarization preserving fiber
	Typical total dynamic range of 10.000:1; direct modulation 500:1
	Diode laser (488 nm, 10 mW); laser class 3B
	Diode (SHG) laser (561 nm, 10 mW); laser class 3B

Power Requirements

LSM 800 has a main power supply cord and country specific plug, NEMA L 14-30P (2/N/Ground 120/240V/30A), and the matching mains socket outlet. The mains socket outlet must be equipped with a fuse having minimum tripping characteristic C according to IEC/EN 60898.

Line voltage	100 V AC ... 125 V AC (+10%)	220 V AC ... 240 V AC (+10%)
Line frequency	50 ... 60 Hz	50 ... 60 Hz
Max. current	1 phase at 5 A	2 phases at 3 A
Power plug	NEMA 5 / 15	Country specific connectors
Power consumption	550 VA (continuous operation; maximum)	575 VA (continuous operation; maximum)
	260 VA (standby operation)	280 VA (standby operation)
	0.011 VA (off mode)	0.025 VA (off mode)
Heat Emission	500 W	500 W

EMC Test

according to DIN EN 61326-1 (07/2013)

1. Noise emission according to CISPR 11 / DIN EN 55011 (04/2011)
2. Noise immunity according to table 2 (industrial sector)

Technical Specifications

- › In Brief
- › The Advantages
- › The Applications
- › The System
- › **Technology and Details**
- › Service

Environmental Requirements

For operation, the system has to be placed in a closed room.

1. Operation, specified performance	T = 22 °C ±3 °C without interruption (24 h a day independently whether system is operated or switched off) It has to be ensured that the airflow of the air-conditioning is not directed at the system.
2. Operation, reduced performance	T = 15 °C to 35 °C, any conditions different from item 1. and 4.
3. Storage, less than 16 h	T = -20 °C to 55 °C
4. Temperature gradient	±0.5 °C/h
5. Warm-up time	1 h for standard imaging; ≥2 h for high-precision and/or long-term measurements
6. Relative humidity	<65 % at 30 °C
7. Operation altitude	max. 2,000 m
8. Loss of heat	500 W

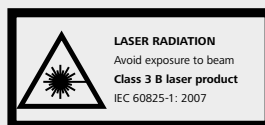

LSM 800 meets the requirements according to IEC 60825-1:2007

Count on Service in the True Sense of the Word

- › In Brief
- › The Advantages
- › The Applications
- › The System
- › Technology and Details
- › **Service**

Because the ZEISS microscope system is one of your most important tools, we make sure it is always ready to perform. What's more, we'll see to it that you are employing all the options that get the best from your microscope. You can choose from a range of service products, each delivered by highly qualified ZEISS specialists who will support you long beyond the purchase of your system. Our aim is to enable you to experience those special moments that inspire your work.

Repair. Maintain. Optimize.

Attain maximum uptime with your microscope. A ZEISS Protect Service Agreement lets you budget for operating costs, all the while reducing costly downtime and achieving the best results through the improved performance of your system. Choose from service agreements designed to give you a range of options and control levels. We'll work with you to select the service program that addresses your system needs and usage requirements, in line with your organization's standard practices.

Our service on-demand also brings you distinct advantages. ZEISS service staff will analyze issues at hand and resolve them – whether using remote maintenance software or working on site.

Enhance Your Microscope System.

Your ZEISS microscope system is designed for a variety of updates: open interfaces allow you to maintain a high technological level at all times. As a result you'll work more efficiently now, while extending the productive lifetime of your microscope as new update possibilities come on stream.



Profit from the optimized performance of your microscope system with services from ZEISS – now and for years to come.

>> www.zeiss.com/microservice



Carl Zeiss Microscopy GmbH
07745 Jena, Germany
microscopy@zeiss.com
www.zeiss.com/sm800



Not for therapeutic, treatment or medical diagnostic evidence. Not all products are available in every country. Contact your local ZEISS representative for more information.

EN_41_011_088 | CZ 11-2017 | Design, scope of delivery, and technical progress subject to change without notice. | © Carl Zeiss Microscopy GmbH